



## HOME DRAUGHT DISPENSE GUIDE

A Basic Troubleshooting & Information Guide | from Taprite Customer Service



## TABLE OF CONTENTS

---

### I. Draught Beer at Home

Available Keg Sizes	2
Keg freshness	3

### II. Temperature

Keg Storage Temperature	4
-------------------------	---

### III. Faucets, Handles, Shanks, and Towers

Handles, Faucets, Shanks, and Towers	5
--------------------------------------	---

### IV. Keg Couplers

How to Tap a Keg	6
How to Change Keg Couplers	6
Beer Brand vs. Coupler	6
Party Pump vs. Coupler	7

### V. CO<sub>2</sub> Control

Restriction	8
Filling a CO <sub>2</sub> Tank	8
Number of Kegs vs. Tank Size	9
Regulator Pressure	9
How to Set a Regulator	10
One vs. Two Gauges	11
Using Multiple Pressures	11
Check Valves and Regulators	12

### VI. Drawing the Perfect Glass

How to Pour the Perfect Beer	13
Special Stout Equipment	14

### VII. Draught System Cleaning

How Often the System should be Cleaned	15
--	----

### VIII. Party Pumps

Party Dispensing Equipment	16
Party Pump Maintenance	17

### IX. Troubleshooting

Common Problems	18
Leak Testing	19

For informational purposes only. The use of products outside manufacturer specifications may cause injury or death. Taprite is not liable for failures related to other manufacturer's products or for damages caused by negligence, misuse or abuse. Please consult your original product instructions and warranty paperwork for additional details. Rv1213

## DRAUGHT BEER AT HOME

### What keg sizes are available to consumers?

These keg dimensions will help you determine what size refrigerator you will need to create a home kegerator.





Type	Home Brew	Home Brew ("Corny Keg")	Sixth Barrel	Quarter Barrel ("Pony Keg")	Slim Quarter	Half Barrel (Full Size Keg)
Gallons	3.00	5.00	5.23	7.75	7.75	15.50
Ounces	384	640	661	992	992	1984
#12 oz. beers	32	53	56	82	82	165
Weight	39 Pounds	49 Pounds	58 Pounds	87 Pounds	87 Pounds	161 Pounds
Coupler	Ball Lock	Ball Lock	Sankey, U, G, A, M	Sankey, U, G, A, M	Sankey, U, G, A, M	Sankey, U, G, A, M

These dimensions and weights may vary slightly as result of differences between keg manufacturers.

Availability of each size of keg will vary by brand of beer and location. You should inquire with your beer supplier to find out which brands of draught beer are available in your area for immediate pick-up, which ones need to be special ordered, and in which size keg those particular brands are available.

When inquiring with your local draught beer supplier, keep in mind that they usually stock only the most popular beer brands and keg sizes. Local draught beer suppliers generally receive deliveries from the beer distributors or breweries once per week. If your preferred brand or keg size is available, and if given a few days notice, the supplier may gladly add it to the next delivery.

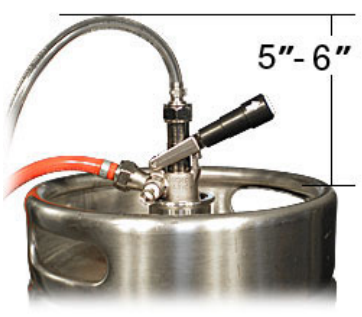
Home Brew Kegs are most often pin lock or ball lock soft drink canisters. Refurbished Cornelius canisters (Corny Kegs) are readily available for use in making beer at home. As these are not directly designed for use with draught beer, the processes and equipment for filling, cleaning, and dispensing from these kegs is different from that of commercial draught systems. Your local commercial or craft brewery may still be willing to fill these kegs with your favorite brand at a special price.

 <p>5" - 6"</p> <p><b>Keg Coupler with Beer Hose</b></p>	 <p>4"</p> <p><b>Keg Coupler with Elbow Fitting</b></p>	 <p>at least 1"</p> <p><b>Low Profile Keg Coupler</b></p>
<p>In general, at least 5" to 6" of clearance needs to be allowed above the keg for the keg coupler and beer hose.</p>	<p>If you have limited space, an elbow fitting can be used to reduce the clearance to 4".</p>	<p>In applications where there is hardly any clearance available, a low profile keg coupler that requires only 1" above the keg can be used.</p>

### How long will a keg of draught beer remain fresh?

All beers are at their best on the day the keg is filled at the brewery. As with many products, as days pass, freshness diminishes. In general, the fresher your keg draught beer is, the better it tastes.

When proper CO<sub>2</sub> pressure and temperature are maintained, keg beer being dispensed will remain fresh:

- Approximately 45-60 days for non-pasteurized draught beers.
- Approximately 90-120 days for pasteurized draught beers.
- Homebrew may remain fresh for 180 days or longer, depending on alcohol content.

*If, for some reason, you must disconnect the CO<sub>2</sub> supply from your keg for an extended period of time, be sure to remove the coupler from the keg to keep additional air out of the system.*

When dispensing keg beer with a party pump:

- Any draught beer will remain fresh for no more than 8-12 hours.
- Oxygen is an enemy of beer.*

For quality assurance, most breweries now print a freshness date on the cap or side of each keg. Depending on the brewery, this may either be a "born on" (filled) date or an "expiration" date, read the label carefully. While the shelf life for each of the brewers may differ, days in inventory before it reaches you are factored into the shelf life of the keg.

**Keg refrigerators use CO<sub>2</sub> driven dispensing**



Here is an example of a keg's life: Non-pasteurized beer has a shelf life of 45-60 days.

- Days 0-10 in transit and/or satellite warehousing
- Days 10-20 in Distributor Warehouse and/or retail delivery routing
- Days 20-60 in retail location and/or final consumer location

*The average commercial keg has 25-40 days of shelf life at a retail location or in a home. Breweries recommend not drinking draught beer once it has passed the freshness date.*

## TEMPERATURE

### At what temperature should draught beer be stored?

Temperature is by far the most important issue when it comes to dispensing keg draught beer, whether commercial or homebrew. Almost all draught beer problems are temperature related.

Most draught beer brewed in the U.S is not pasteurized, so it must be kept cold. The temperatures of non-pasteurized Ale and Lager type beers must be kept between 36-38°F all the way to the point of dispense.



*Liquid Thermometer*

Temperatures even half a degree above 38°F will cause CO<sub>2</sub> to break out of the beer, resulting in foam and promoting sour/cloudy beer. When temperature rises above 50-55°F, bacteria growth rapidly begins to spoil flavor and cloud the beer. Simply put, keg beer storage can be compared to milk storage – warm beer will spoil.



*Ales and Lagers are best served at 38°F*

The air temperature in the refrigerator can fluctuate greatly when the door is opened. As such, it is important to check the "liquid" temperature of the beer rather than the air temperature in the refrigerator.

The ideal method for monitoring the liquid temperature (inside the keg) is through use of a liquid thermometer. Such thermometers are enclosed in a casing filled with liquid; this provides a constant accurate reading of the liquid (beer) temperature within the refrigerator.

Another method for monitoring the liquid temperature (beer inside the keg) is to put a glass of water in the refrigerator with a thermometer in it. Allow the water to chill for 24 hours, and then you will have an accurate reading of the "liquid" temperature.

Additionally, if your draught beer is being dispensed away from the refrigerator, the temperature of the dispensed beer should be monitored. This is to make sure the 36-38°F temperature is being maintained all the way to the point of dispense.

To check the dispense temperature, simply pour beer into a glass and use a thermometer to read the temperature – in a proper system this will match the liquid temperature inside the kegerator.

If a walk-in cooler is being used for keg storage, try to limit the traffic in and out as opening and closing the cooler will result in increased storage temperatures. If this cannot be prevented, it is recommended to install flexible clear plastic air curtains or an electric air curtain to prevent cold air from being lost when the cooler is opened.



## HANDLES, FAUCETS, SHANKS, & TOWERS

### Will all faucet handles fit all faucets?

All draught beer faucets and handles manufactured for the U.S. market have the U.S. beer industry standard 3/8"-16 UNC threads. Those manufactured for markets outside U.S. have a European metric thread specification.

This means that faucet handles with European threads will not fit faucets with U.S. threads, and faucet handles with U.S. threads will not fit faucets with European threads. However, all faucet handles and faucets produced in the U.S., even if made by different manufacturers, are interchangeable as they have the U.S. beer industry standard 3/8"-16 UNC threads.

Currently there is no adaptor piece available for fitting handles with European threads to faucets with U.S. threads or vice versa.



### Will all faucets fit all shanks?



There is a dimensional difference between shanks and faucets manufactured for the U.S. market and those manufactured for markets outside U.S.

Those for the U.S. are manufactured to U.S. beer industry standard thread specifications, whereas those for outside U.S. are manufactured to European metric thread specifications. Please be aware that if your dispensing equipment was manufactured outside the U.S., there is a good possibility the U.S. faucet will not be compatible.

However, all shanks and faucets produced in the U.S., even if made by different manufacturers, are interchangeable as they have the U.S. beer industry standard threads.

### Will all faucets fit all towers?

Just as with shanks and handles, all faucets manufactured for the domestic market have identical threading. Faucets for American towers and shanks have 1 1/8" – 18 UNEF male threads and are interchangeable across the broad spectrum of design and function.

### Can I expand my draft tower setup without replacing all of my equipment?

While most kegerator systems come equipped to dispense one or two beer flavors from the time of initial setup, simple changes can be made to help you accommodate and serve more beer flavors at the simultaneously.

The 8-hole mounting pattern for all standard, domestic 2.5" diameter draught towers is the same. This is also true for the 4-hole pattern on 3" diameter towers. The pattern for 3" draft towers is actually standard for both pedestal type and T type towers. This makes switching your kegerator's external hardware a reasonably easy prospect.



In general, standard pedestal towers are manufactured with no more than 3 faucets. Replacing the pedestal tower with a T-Tower will provide you with the opportunity to use up to 6 faucets with the existing, 3" flange/pedestal space. In many cases, T-Towers with more than 6 faucets are manufactured using two pedestals to provide stability. The space constraints of your refrigerator and the availability of tower mounting space will ultimately determine the maximum number of faucets and kegs that can be used with your system.



When space prevents the addition/replacement of towers, use of tower adaptors is recommended. Adaptors allow addition of 1 or two faucets to the top of an existing 3" tower.



## KEG COUPLERS

---

### How do I tap a keg?

#### For the American "D" system, European "S" system, and "U" system keg couplers:

1. Ensure the keg coupler handle is in the upright (OFF) position.
2. Align the two coupler lugs with the corresponding openings in the keg valve.
3. Insert the keg coupler and turn clockwise to engage into position (about 90 degrees).
4. Press the handle downward (ON) this will allow gas to enter the keg and beer to flow out of the keg.

#### For the Grundy "G" system keg coupler:

1. Ensure the keg coupler handle is in the upright (OFF) position.
2. Align the triangular coupler opening with the keg valve.
3. Place keg coupler onto the valve and turn clockwise to engage into position (about 90 degrees).
4. Press the handle downward (ON) this will allow gas to enter the keg and beer to flow out of the keg.

#### For the German Slider "A" & "M" system keg couplers:

1. Ensure the keg coupler handle is in the upright (OFF) position.
2. Align the base of coupler with the side of the keg valve.
3. Slide keg coupler onto the keg valve.
4. Press the handle downward (ON) this will allow gas to enter the keg and beer to flow out of the keg.

#### For the Twin Probe keg coupler:

1. Align the two coupler probes with the corresponding openings in the keg valve.
2. Push keg coupler into the valve.
3. Tighten the threaded coupler to the valve.
4. Turn on CO<sub>2</sub> source.

### Is it easy to change from one system of draught beer keg coupler to another?

All standard keg couplers produced for the U.S. commercial beer market have the U.S. beer industry standard 7/8"-14 threads on both the gas-in and beer-out ports. This universality of threads allows easy switching of keg couplers without the need to cut hoses or remove clamps. Quick disconnects are available for use with multiple couplers.

Twin probe couplers, commonly used by microbreweries and craft breweries, do not have a threaded gas port. Ball Lock couplers used for dispensing home brew beers lack threaded ports as well. Quick disconnects are available for quick changes between commercial and home brew kegs.

To change from one coupler to another, first turn off the CO<sub>2</sub> gas using the shut-off valve on your regulator and the CO<sub>2</sub> tank knob. Then, on the coupler being removed, simply loosen the hex (or wing) nut fittings on both the gas and beer hose assembly and remove the hoses from the coupler. Then simply re-connect the hoses to the coupler you are wishing to use, and re-tighten the hex (or wing) nut fittings. Lastly, turn on the CO<sub>2</sub> gas using the shut-off valve on your regulator and CO<sub>2</sub> tank knob.

### Do all brands of beers use the same keg tapping equipment?

Not all brands of draught beer use the same type of valve in the keg. Each distinct "system" requires matching the appropriate keg coupler to the keg valve. In the US, there are eight different "systems" in use. These are:

- ["D" System \(American Sankey\)](#): Most North American beers. Used by breweries such as Budweiser, Coors, Miller, Labatt and Molson.
- ["S" System \(European Sankey\)](#): Many import beers. Used by breweries such as Heineken, Becks, and Amstel Light.





M Style Keg Coupler



A Style Keg Coupler

- **"A" System (German Slider):** Many German beers. Used by breweries such as Spaten, Warsteiner, and Paulaner.
- **"M" System:** Body is the same as the German Slider, but the probe configuration is unique. Used by breweries such as Schneider and Aventinus.

- **"G" System:** Takes its name from the English developer Grundy. Used by breweries such as Bass, Boddington's, Caffrey's and Anchor Steam.
- **"U" System:** Takes its name from the English manufacturer UEC. Used by breweries such as Guinness and Harp.



U Style Keg Coupler

- **Home Brew:** Ball Lock and Pin Lock Couplers are for homebrew kegs.
- **Twin Probe:** Used by some Craft Breweries



G Style Keg Coupler



Pin Lock Couplers



Ball Lock Couplers



Twin Probe

For those brands of beer not covered in our listing, we recommend simply inquiring about the system of keg coupler with the company you are purchasing your kegs from. If they do not know, they can make a quick call to the beer distributor or brewery to find out this information for you.

### What is the difference between a party pump and a keg coupler?

Party pumps dispense beer by use of outside air pumped into the keg via a hand pump.

This type of dispensing is appropriate only when the beer will be consumed within a few hours, because the outside air will cause a bacteria reaction that will spoil the beer within 8-12 hours.



Party Pumps use air to pressurize a keg.



D Style Keg Coupler

Keg couplers dispense by use of pressurized gas from a gas cylinder. For Ale and Lager type beers, carbon dioxide (CO<sub>2</sub>) is used. For Stout type beers, mixed 75% Nitrogen / 25% carbon dioxide gas is used. This type of dispensing will allow the beer to remain fresh, if kept at the proper temperature and pressure, for 45-120 days.



Coupler Probe Face View





## CARBON DIOXIDE CONTROL

### What is restriction?

When dispensing keg draught beer, the goal is to keep the CO<sub>2</sub> level prescribed by the Brewer. Any change in the CO<sub>2</sub> level will alter the taste, pouring characteristics and appearance of the beer. Most breweries in the U.S. recommend a CO<sub>2</sub> pressure between 12-14psi for Ale & Lager draught beers. This CO<sub>2</sub> pressure is meant to maintain the level of carbonation specified by the brewery.

Beer hose is used to transport the beer from the keg to faucet and is also used to control how fast the beer pours from the faucet. The way this works is the length and inner diameter (I.D.) of the beer hose is calculated to "balance" against the CO<sub>2</sub> pressure that is applied to the keg. This controls the beer flow and assures the beer dispensed from the faucet is neither too fast nor too slow. This is called "restriction". The more restriction added to a system the slower the beer flows from the faucet.

Most beer towers are equipped with 5' of (3/16" I.D.) vinyl beer hose. This is because this size and length of tubing allows for appropriate restriction in most keg refrigerators dispensing at 12-14psi.

In applications where the distance between the keg and faucet is greater than 5', a larger size (I.D.) of hose should be used to balance the system. When 3/16" I.D. vinyl beer hose is longer than 5', the beer flows too slowly and there is too much restriction in the system for the amount of CO<sub>2</sub> pressure. In some, system installers increase the CO<sub>2</sub> pressure to overcome the restriction. While this forces the beer to flow faster it is likely to become over-pressurized, causing the beer to foam. It is also very important not to kink the beer hose as it leaves the coupler, this will also restrict flow and cause foaming.

To assure the best glass of draught beer industry experts recommend setting the CO<sub>2</sub> pressure to the Brewers' specification and controlling the flow rate with the proper length and diameter of beer hose.

### Where can I get a CO<sub>2</sub> cylinder filled?

You should inquire with your beer supplier to find a nearby company that fills CO<sub>2</sub> gas cylinders.

If they are unable to recommend a company, another option is to look in your phone book under Fire Extinguishers or Fire and Safety Equipment. Companies that refill fire extinguishers are typically willing to fill CO<sub>2</sub> cylinders, while paint ball equipment suppliers and sporting goods stores may provide additional service locations. Although it will vary with each market area, the average cost for filling a 5 Lb. CO<sub>2</sub> gas cylinder is \$16.



*Depending on your location, the cost of filling a 5lb CO<sub>2</sub> cylinder is between \$12 and \$20*

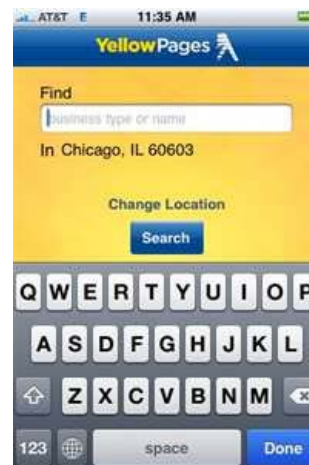

*Local Paintball Suppliers or Fire Safety Companies may also offer CO<sub>2</sub> filling services*



### How many kegs of draught beer can be dispensed from one CO<sub>2</sub> tank?

As a general rule of thumb, it takes about a 1lb of CO<sub>2</sub> to dispense a ½ barrel of draught beer. A properly filled gas tank will show a pressure of about 850psig at 72°F, but may be slightly lower or higher depending on temperature. The pressure should read in the 850-900psig range until the liquid CO<sub>2</sub> in the cylinder is depleted. The table below lists the approximate number of kegs that can be dispensed by each size of CO<sub>2</sub> cylinder.

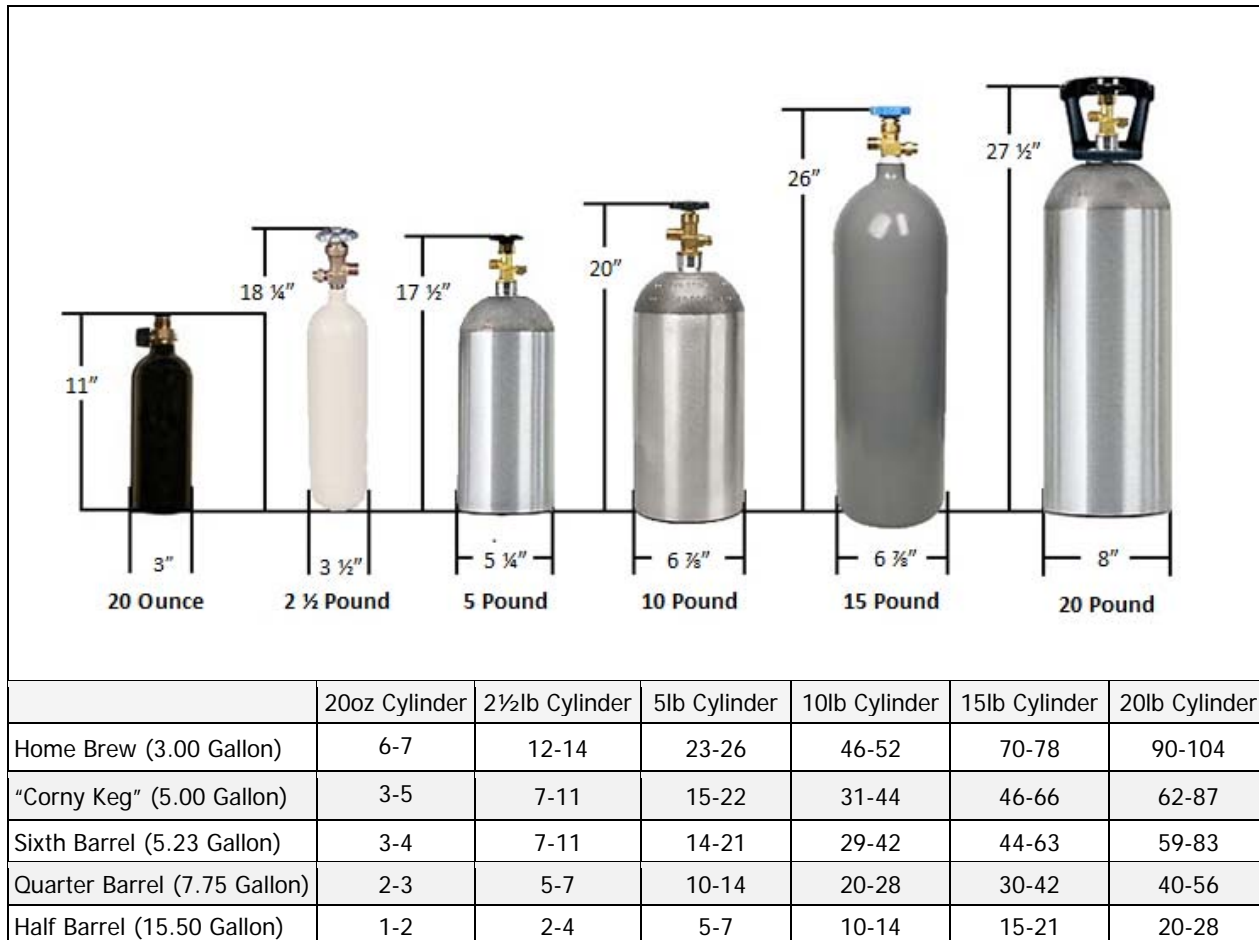

### At what pressure should I set my CO<sub>2</sub> regulator?

When dispensing keg draught beer, the goal is to keep the CO<sub>2</sub> level prescribed by the brewer. Any change in the CO<sub>2</sub> level will alter the taste, pouring characteristics and appearance of the beer.

Most breweries in the U.S. recommend a CO<sub>2</sub> pressure between 12-14psi for Ale and Lager types of draught beers. This CO<sub>2</sub> pressure will maintain the level of carbonation specified by the brewery. Stout beers require different settings, often up to 38psi, with the use of mixed gas.

If you are unsure of the recommended CO<sub>2</sub> pressure for the beer you are dispensing, simply inquire with the company who sold or rented the keg to you. If the vendor does not know, he/she can make a quick call to the beer distributor or brewery for the information.



If the draught beer is dispensed at too low a pressure, the CO<sub>2</sub> that is dissolved in the beer will “break out”. Initially, this will cause small bubbles of CO<sub>2</sub> to float upward through the system and result in foamy beer at the pour. Over time, the loss of CO<sub>2</sub> to low pressure will result in flat beer.

If the draught beer is dispensed with too high a pressure, elevated amounts of CO<sub>2</sub> will be absorbed into the beer. Initially, this will not cause any problems, but over time this will result in over-pressurized foamy beer.



Too Much CO<sub>2</sub>



Proper CO<sub>2</sub> Level



Too Little CO<sub>2</sub>

## How do I set a regulator?

Once the regulator is securely attached to the gas cylinder and the coupler attached to the keg:

<p>A</p>	<p>B</p>	<p>C</p>
<p>With the shutoff valve on the regulator closed, open the valve on the gas cylinder completely. The handle on the shutoff should be perpendicular to the tubing.</p>	<p>With your fingers or a pair of pliers, loosen the adjustment nut, allowing the screw to be turned. Turn the screw counterclockwise until it can no longer be turned.</p> <p>If you are using a regulator with a polycarbonate bonnet, pull the bonnet cap out by hand to allow adjustment. Turn the knob counterclockwise to the stop position (turning past the stop position will damage the adjustment knob).</p>	<p>Slowly turn the regulator adjustment screw or knob clockwise until the desired pressure is shown on the on the output pressure gauge. Turning clockwise will increase the output pressure and you will feel greater resistance as psi setting goes up. Tighten the adjustment screw or snap the cap back down to “lock in” your pressure setting.</p> <p><b>Note:</b> Most domestic beer companies recommend setting the regulator at 12psi for Lager or Ale. As this may not be true for higher altitudes or special beer brands, please consult your keg provider or brewer for details.</p>
<p>D</p>	<p>E</p>	<p>F</p>
<p>Open the shutoff valve on the regulator to allow gas to flow from the regulator to the keg coupler. You will now hear the keg pressurizing. The output pressure needle will drop momentarily and the return to your set pressure once this is complete.</p>	<p>The keg coupler is designed with a built-in pressure relief valve (PRV). Pull the ring on the PRV and hold it open for 5-6 seconds, allowing gas to vent. This will permit full gas flow through the regulator and help to obtain a more accurate reading on the output gauge.</p>	<p>Re-check the output pressure on the regulator and readjust if necessary, using steps B and C, until the desired pressure is reached.</p> <p><b>Note:</b> It is always wise to follow up on any adjustments to the regulator with a brief pull of the PRV ring to ensure accurate output reading.</p>

What is the difference between a regulator with one gauge and one with two gauges?



Single Gauge Regulator

Output Pressure Gauge

Output Pressure Gauge

Tank Pressure Gauge

Dual Gauge Regulator

A typical single gauge CO<sub>2</sub> gas regulator has a 0-60psi pressure gauge showing the gas output pressure.

A typical dual gauge CO<sub>2</sub> gas regulator has a 0-60psi pressure gauge showing the gas output pressure, and a 0-2000psi pressure gauge showing the amount of gas remaining in the gas cylinder (tank).

**How do I setup the gas equipment for two draught beers that require different CO<sub>2</sub> pressures?**

When dispensing multiple draught beers that require different CO<sub>2</sub> pressures, it is necessary to use either ganged primary gas regulators or secondary gas regulators to control the specific pressure for the different beers.

When dispensing multiple draught beers that use the same CO<sub>2</sub> pressure, ganged primary gas regulators or secondary gas regulators are not required. Rather, a gas distributor can be used to simply split the gas flow to the different beers.



Ganged Primary CO<sub>2</sub> Regulator



Secondary Regulator Panels are typically used in Bar and Restaurant installations.



Gas Manifolds



**Do gas regulators need to have check valves?**

A gas check valve is a one way device allowing gas to flow only in one direction - when the gas is not flowing, the check valve seals, preventing any backflow. Taprite regulators are generally equipped with a check valve in the shutoff to prevent the backflow of gas in an inverse pressure situation.

Gas regulators designed for use in the draught beer industry normally include standard shutoff valves, but these may or may not include a check valve. This is because shutoffs with check valves are not necessarily required for all draught beer dispensing applications. For additional safety, all standard keg couplers (for use with commercial beer) have a built in gas check valve. This prevents the back flow of beer from the keg into the regulator.

*All standard couplers for commercial keg use have built in gas check and relief valves.*



Homebrew couplers, however, do not have a built in gas check valve. As such, it is important to use regulator shutoff(s) with a check valve when using homebrew couplers. This is important because without a check valve, any loss of gas pressure will result in the beer backing up into the gas line and into the regulator.

If purchasing a gas regulator for use with homebrew couplers, be sure to purchase a shutoff with a check valve. The standard shutoff on the regulator can be replaced.



*Homebrew keg couplers DO NOT have built in gas check/relief valves.*



*Many shutoff valves do not have built-in checks as a standard features.*

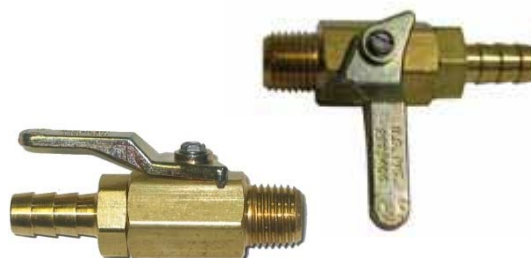

*Always use a shutoff with a built-in check valve with Ball Lock and Pin Lock Couplers.*



## DRAWING THE PERFECT GLASS OF BEER

### For Ale & Lager type of beers, the pouring process is:

Start with a glass clean of any residue, including soap film.



1 Place the glass at a 45° angle, one inch below the faucet. Do not let the glass touch the faucet. Open the faucet completely in one, swift motion.



2 After the glass has reached ½ full, gradually bring the glass to an upright position.



3 Let the remaining beer pour straight down the middle. This ensures proper release of CO<sub>2</sub> by producing a ¾" to 1" foam head.



4 Close the faucet completely and quickly.

### For Stout type of beers, the pouring process is:

Start with a glass clean of any residue, including soap film.



1 Place the glass at a 45° angle, one inch below the faucet. Do not let the glass touch the faucet. Open the faucet all the way in one, swift motion.



2 Once the glass is ¾ full, close the faucet completely in one, quick motion.



3 Place the glass on the bar counter and allow the surging beer to settle.



4 Once the surge has settled, fill the glass to the brim, pouring straight down the middle of the glass. Close the faucet completely in one, swift motion.

**\*\*A clean glass is crucial to the perfect pour. Glasses washed with other items that have contained fatty substances may cause loose foam. Wash glasses with proper detergent, rinse with cold water, and air dry.\*\***



**Do I need special equipment to dispense a Stout beer such as Guinness or Murphy's?**

Stout type beers, such as Guinness® and Murphy's®, require Stout type faucets and a two-part pour method to achieve their distinctive, cascading head. The unique Stout faucet has an integrated restrictor disc, through which the beer is forced. The restrictor disc breaks the Nitrogen out of the beer, and creates the distinctive cascading head of Stout beers. The restrictor disc must be left in place, and cleaned frequently to remove any buildup that may clog the tiny holes in the disc. It takes about 2 minutes to pour the perfect pint of Stout beer.



Although most bars and restaurants store their Stout beers at the 36-38°F temperature (which is critical for most non-pasteurized Ale and Lager type of draught beers), most

*Stouts are best served at 42°F*



breweries recommend their Stout beers are served at a temperature of 42°F to get the best flavor attributes of their product.

**Stout Beers require Stout Faucets to achieve their distinctive cascading head.**

Always verify with your local beer distributor the brewery recommended temperature and type of gas for the beer you intend to dispense.



To retain the taste the breweries intended, Nitrogenous beers need to be dispensed with a Stout type faucet, a 75% Nitrogen / 25% CO<sub>2</sub> gas blend, and a dispense pressure of 38psi.

The gas is a 75% Nitrogen / 25% CO<sub>2</sub> gas blend and is commonly referred to as Guinness gas. This gas blend is inappropriate for Ales and Lagers type of draught beers, as it will change the CO<sub>2</sub> content and thus, the flavor of these beers.



**S Couplers are used for Stouts like Murphy's while Guinness uses the U Coupler**

Cylinders of mixed gas can usually be purchased locally. We recommend inquiring with your keg supplier to find a local source of mixed gas, or looking in your phone book under Gas or Welding supply stores. Remember to request gas for use with beverages.

While most 75% Nitrogen / 25% CO<sub>2</sub> gas blend cylinders have a valve for use with a Nitrogen regulator (CGA-580 threads), there are some companies that supply 75% Nitrogen / 25% CO<sub>2</sub> gas blend cylinders with a valve for use with a CO<sub>2</sub> regulator (CGA-320 threads).



Find out from your supplier what kind of valve is on the mixed gas cylinders they offer. If the valve on the cylinder is for Nitrogen and you already have a CO<sub>2</sub> regulator, you can easily adapt your CO<sub>2</sub> regulator to a Nitrogen valve cylinder by using a regulator adaptor. **For your safety, never use or convert a CO<sub>2</sub> regulator for use with Nitrogen alone. The Nitrogen tank's higher pressure may damage to your CO<sub>2</sub> regulator and cause bodily harm or death.**

**Most mixed gas cylinders have valves for use with Nitrogen regulators.**

## DRAUGHT SYSTEM CLEANING

### Do I need to clean the equipment and how often?

Regular cleaning of the faucet, beer hose, and keg coupler is extremely important. If this is not performed, the beer will foam. Additionally, bacteria, yeast, mold, and beer stone will build up and quickly degrade the quality of draught beer. The simple process of cleaning your draught beer system takes only a

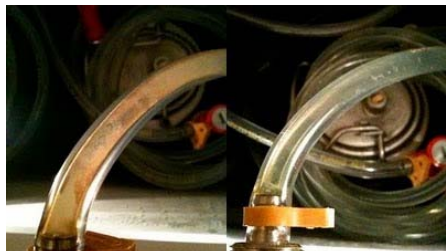

*Dirty beer lines are saturated with “beerstone” residue. This calcium buildup forms in small spots in the hose and harms beer quality. Clean lines are a vital part of good flavor.*

This basic process involves pumping water mixed with cleaning chemical into the beer hose and letting it soak for the time prescribed by the chemical manufacturer. Be sure to thoroughly flush the beer cleaned hose with water to remove all traces of chemicals.

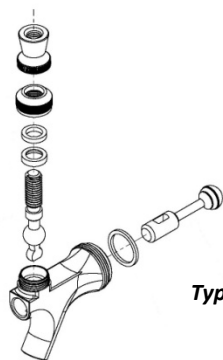

*Typical Beer Faucet Parts Diagram*

The most often overlooked step is cleaning the keg coupler and faucet. The parts should be soaked in water mixed with cleaning chemicals, scrubbed with an appropriate cleaning brush, and rinsed with clean water. These parts can easily be fully disassembled. Simply pouring warm water over the fixtures at the end of the day can help prevent build-up as well.



*Cleaning Pump and Tools*

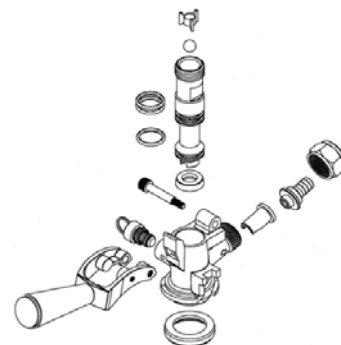

*Typical Keg Coupler Parts Diagram*

As a maintenance habit, it is always good to make sure the probe o-rings and bottom seal on the keg coupler are in good condition after each cleaning. The friction washer, coupling washer, and shaft seat on the faucet should also be in good condition.

You should also make sure the probe o-rings on the keg coupler are properly lubricated, with a food grade lubricant, to allow the keg coupler to work freely and to prevent wear and tear that can occur when the keg coupler is tapped and untapped. For a better understanding of these parts, see a typical keg coupler diagram and faucet diagram.

In general, home draught systems should be cleaned after every keg or at a minimum of every two weeks. Routine cleaning is essential to maintain the quality and fresh taste draught beer has to offer.

**Please note:** Draught beer systems should only be cleaned with chemicals that are specifically designed for beer line cleaning. For your safety, it is important that all directions on any chemicals are followed completely.



## PARTY PUMPS

### What different methods are available for dispensing draught beer at a party?



There are a wide variety of methods available for dispensing draught beer at a party. No matter which method of dispensing is used, remember to keep the keg chilled to 38°F for both dispensing and storage.

Keg Party Pumps are the most commonly used method to dispense draught beer at parties and single use events. Pressure to dispense the beer is provided by a hand operated pump which forces air into and beer out of the keg.

Party pumps are generally used in single keg special events environments, with the beer being consumed within a few hours, because the outside air pumped into the keg will cause a bacteria reaction that will spoil the beer within 8-12 hours.

Party Dispensing Systems that use CO<sub>2</sub> are the ultimate way to dispense draught beer at a party. The pressure is provided by a CO<sub>2</sub> tank so there is no need to pump the keg as with a traditional party pump. Just open the faucet and let the beer

flow. Using CO<sub>2</sub> dispense will also help to maintain the freshness of draught beer longer than with party pumps, as pumps force unfiltered air to the keg. If the draught beer is kept at the proper temperature and pressure, CO<sub>2</sub> use will help to keep beer fresh in excess of 45 days.

Basic CO<sub>2</sub> Party Dispensing Systems are available in a wide variety of configurations. The most common models feature a plastic hose and picnic faucet attached to a basic hand pump. More expensive units may feature lever handle pumps, multiple hoses, upright dispensing rods, and even chrome faucets.



*Party Pumps may have multiple hoses.*

### What is the proper way to dispense beer using a party pump?

A common mistake when operating a party pump is to pump first and then open the faucet. This generally results in a faster (foamy) pour.

To properly dispense Draught Beer using a Party Pump:

1. Tap the Keg.
2. Open the Faucet until all the pressure is relieved.
3. Open the Faucet and begin pumping until the desired flow rate reached.
4. Stop pumping.
5. Only pump with faucet open and only pump to maintain a good beer flow. **Pumping with the faucet closed will result in a faster, foamy pour, as will pumping too much.**
6. Repeat step #3 until keg is empty.

After purchasing the keg it is recommended to cover the keg with a blanket or Keg Jacket. This will help insulate the keg and keep it cool during transit. Once the keg is to the location in which it will be dispensed, put the keg in a barrel of ice. Remember, keg beer is best served cold (36°-38°F). If not kept cold, excessive foaming will occur. Keep pump and keg out of direct sunlight. When not in use, submerge beer line and faucet in ice on top of keg. If you have partially dispensed a keg using a party pump (air) you should not use CO<sub>2</sub> to finish dispensing it. When using a party pump, the keg must be finished the same day for best flavor. To prevent damage to the pump and keg, never use the pump to lift the keg.



### How can I easily clean a party pump?

After each use, be sure to clean your party pump with chemicals specifically manufactured for beer line cleaning.

This simple process takes only a few minutes and will assure trouble free operation when the party pump is next used. Cleaning is most easily and most often done through use of a pressurized cleaning bottle.



1. Remove the cleaning bottle cap. Mix cleaning chemicals with water per manufacturer's instructions.
2. Screw cap back on to bottle and engage party pump as if tapping keg.
3. Pressurize cleaning bottle with party pump and release cleaning solution by squeezing faucet, allowing approximately 1 quart to flow out.
4. Pull pressure relief valve to release bottle pressure before removing bottle cap. Remove bottle cap. Pour fresh water into cleaning bottle. Screw bottle cap back on and engage party pump.
5. Pressurize cleaning bottle with party pump and release fresh water by squeezing faucet, allowing approximately 1 quart to flow out.

## TROUBLESHOOTING

---

### Almost all dispensing problems are the result of:

- ❏ Improper temperature
- ❏ Improper pressure
- ❏ Cleaning issues

#### Quick checklist:

- ✓ Is the keg stored between 36-38°F, and is the same temperature maintained all the way to the point of dispense?
- ✓ Is the CO<sub>2</sub> pressure between 12-14psi (38psi for Stout beer)?
- ✓ Have the faucet, beer line, keg coupler, and beer glasses been cleaned (with chemicals specifically manufactured for beer hose cleaning) on a regular basis?

Troubleshooting problems that occur is an important part of maintaining your draught system. If you place a clean beer glass at a 45° angle under your faucet, open the tap all the way, and . . .

- **No beer comes out.** When troubleshooting, always check the most obvious thing first. Is the keg empty? If it is, you will feel a rush of gas coming from the faucet as gas escapes from the keg through the line. Is the coupler on the keg correctly? Is the carbon dioxide tank connected, is it full, and are the valves open? Is the line frozen?
- **Cloudy beer comes out.** Has the beer been chilled to below 36°? Did you pour properly? Is the faucet damaged or dirty? Are the valves in the keg coupler working properly? Keg couplers, like faucets, should be kept clean to prevent bacteria growth. Defective valves may cause bacteria growth as well.
- **Flat, headless beer comes out.** If the head goes away too quickly or doesn't form to begin with, first check the regulator gauge for proper setting. Is the beer glass clean? Did you pour properly? Is your beer system too cold? Is there a CO<sub>2</sub> leak in your system or an improper CO<sub>2</sub> setting on your regulator? If your system doesn't fill a 10 ounce glass in 4 seconds (2 ounces per second), there may be obstructions in your line or issues with your regulator setting.
- **Foamy, overcarbonated beer comes out.** Is the keg empty? Is the regulator set to the proper pressure? Is the keg storage temperature at the proper temperature of 36° to 38° F? Did you open the tap all the way and pour properly? Has the keg had time to settle? Is there a kink, dent, or twist in the beer line? Is there a sag or trap in the beer line (the line should be leading up from the keg to the faucet)? Is your faucet secured tightly to prevent beer from draining back into the keg? Is there yeast buildup in the faucet? Is your low pressure gauge working/reading correctly? On a long-draw system, is the coolant cold enough? The glycol reservoir for the coolant should stay right around freezing, plus or minus two degrees.
- **The beer starts out fine, but then the line "burps."** There is a warm spot, kink, pinhole, soil deposit, or bad seal somewhere between the keg and the faucet. A full keg might be sitting on the hose in the walk-in, crimping the line. Check insulation and seals. Clean your beer lines.
- **The beer is not flowing fast enough.** Your keg beer refrigerator may be off balance. If your beer line is too long, it may hinder the flow of beer. Take into consideration the length, the resistance according to diameter, and the optimal pressurization of the beer you are serving.
- **The beer doesn't taste right.** Have the lines and components been cleaned recently? Beer lines should be cleaned at least every three weeks, preferably weekly. Are the glasses beer-clean? Is air being introduced to the beer somewhere in system by a leak or loose component? Are you using stainless or other tubing not approved by the brewery? Has the keg passed its "best by" date or spoiled during unrefrigerated storage?



- **The beer is darker than usual or cloudy, and it doesn't taste right.** Clean the lines. Check the expiration date on the keg. Has the keg been tapped for more than three weeks? Is the keg getting warmer than 45° F during storage?
- **There are little black flakes or slimy chunks in the beer.** Clean the lines. Clean and maintain the faucets. Don't panic - these flakes and slimy chunks aren't harmful, just disgusting. Sometimes a line cleaning will loosen deposits that appear in subsequent beers.
- **The first few pours of the day are all foam, but then it's okay.** This means that your pressure and temperature are not staying the same. If your beer cooler gets a lot of traffic during the day, the temperature will rise. Your gas regulator is set to give a good pour at the daytime temperature. Overnight the beer dissolves more CO<sub>2</sub> because the gas pressure stays the same but the beer gets colder. If you can limit traffic by storing only kegs in your keg cooler, this will fix the problem. If you can't do that, try hanging a slatted plastic air-barrier screen in the doorway to minimize cold-air loss. If this isn't possible, try turning off the valve from the carbon dioxide regulator at night. Just don't forget to turn it back on in the morning.
- **The last third of a keg is foamy.** This is the same problem as above. As the beer is replaced by carbon dioxide in the keg, the area of contact between the gas and the beer stays the same, but the volume of beer is smaller. This allows the beer to dissolve the gas more quickly.

## How do I find a CO<sub>2</sub> leak in my draught system?

### Step 1:

Leave all valves open and your keg coupler in position.

Be sure that no one is dispensing while you test.

Turn the gas cylinder wheel off and observe the high pressure gauge (indicating pressure in cylinder).

If the needle drops, your leak is somewhere in the system. If not, go to step 2.

### Step 2:

Turn off all valves and raise the handle on the keg coupler to turn off the beer keg, but leave the coupler in the keg well.

Turn the gas cylinder wheel back on to pressurize the system, and then turn it off, noting the needle on the high gauge. If it drops, your leak is right at the regulator since the shutoff below it is in the off position. Check for wear in the gasket between the regulator and the cylinder; this is a common area for wear and source of leaks. If not, then your leak is downstream: move to step 3.

### Step 3:

Open the regulator shutoff and turn the gas cylinder on and off. Continue the process until you isolate the leak using soap, Windex, or another standard detection method/device.